

Installation Instructions

Ironclad® SRSEM LED Emergency Light

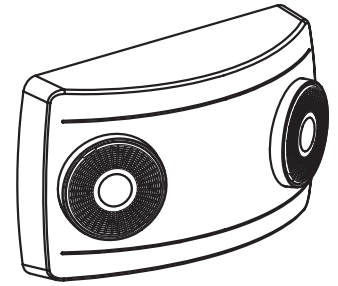

Read and Follow all Safety Instructions:

1. Disconnect power at fuse box or circuit breaker before installing or servicing.
2. DO NOT use outdoors.
3. DO NOT mount in hazardous locations, or near gas or electric heaters.
4. DO NOT let power cords touch hot surfaces.
5. Equipment should be mounted in locations and at heights where it will not be subjected to tampering by unauthorized personnel.
6. The use of accessory equipment not recommended by manufacturer may cause an unsafe condition.
7. Do not use this equipment for other than intended use.
8. All servicing should be performed by qualified personnel only.
9. Allow battery to charge for 24 hours before first use, for 2 batteries model, need 48 hours fully charge batteries.

Use Flexible Conduit Only

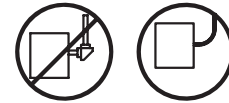

***Save These
Instructions***

Maintenance

None required. Replace the batteries as needed according to ambient conditions. However, we recommend that the equipment be tested regularly in accordance with local codes.

Operation

Press the test button. The LED heads will turn on and the LED indicator will turn off. Release the test switch, LED heads will turn off and the LED indicator will turn on.

Trouble Shooting Guide

If LED heads or LED indicator does not illuminate, check the following:

- Check AC supply - verify that unit has 24 hours AC supply.
- Unit may be shorted or battery may not be connected.
- Battery discharge. Permit unit to charge for 24 hours or 48 hours (for 2 batteries model) and then re-test.
- If above trouble shooting hints do not solve your problem, contact factory for assistance.

Installation

1. Use flat blade screwdriver, insert into the two slots and pry off front cover from back plate. (Fig. 1)

Wall Mount - Back Power Feed (Fig. 2)

1. Remove center knockout and appropriate screw hole knockouts in back plate.
2. If using vandal cover, (See second page Vandal Cover Steps 1- 4), before proceeding.
3. Feed J-Box wires through center knockout hole and secure back plate to J-Box.
4. Connect the J-Box wires to the power supply wires using the wire nuts provided. Connect the white wire to neutral. If using 120V, connect the black wire to the hot lead. If using 277V, connect the orange wire to the hot lead. Cap the unused lead. Press the wires into the J-Box (refer to wiring diagram below Fig. 5).
5. (If applicable) Connect remote heads. Refer to below instruction for remote heads.
6. Connect battery connector. (Fig. 2)
7. Snap the front cover onto the back plate.
8. Restore power and press test button. LED heads will turn on.
9. Adjust the lamp head and lens direction as needed. (Fig. 5)

Ceiling Mount - Top Power Feed (Fig. 3)

1. Refer to all above Wall mount instructions except for the below:
2. Mount back plate on the ceiling surface instead of the wall surface.
3. Feed building AC supply through the back plate and then connect to fixture power supply wires using provided wire nuts.

Conduit Mount (Fig. 4)

1. Open front cover and remove top knockout on the top flange of fixture.
2. Secure conduit (on surface raceway) to knockout and feed wires.
3. Remove keyhole knockout on back plate and mount to wall.
4. Refer to above 5 - 10 steps in Wall Mount Section.

Connecting Remote Heads (Fig. 2)

1. Attached remote wire on remote connector on PCBA, Connect remote heads extended wire to remote wire, yellow is positive (+), purple is (-). Connect wires using wire nuts.

Wiring Diagram

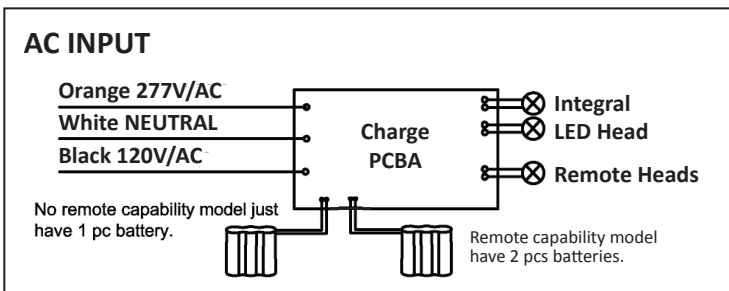

Max. mounting height: TCL1: 15ft. TCL2/TCL4: 26ft.

Open Fixture

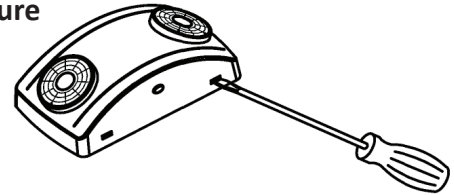

(Figure 1)

Wall mount-Back Power Feed

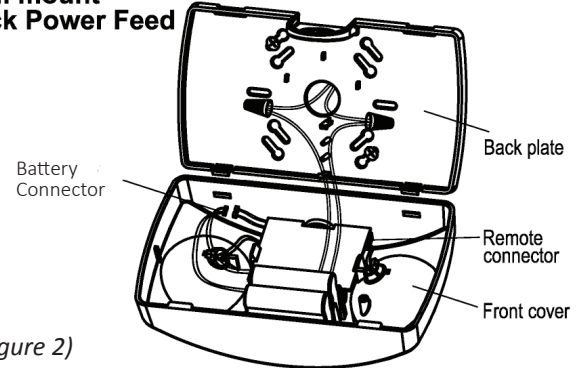

(Figure 2)

Ceiling Mount-Top Power Feed

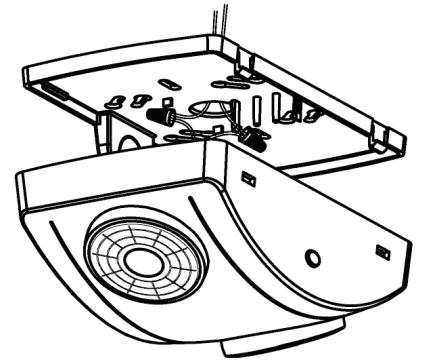

(Figure 3)

Conduit Mount

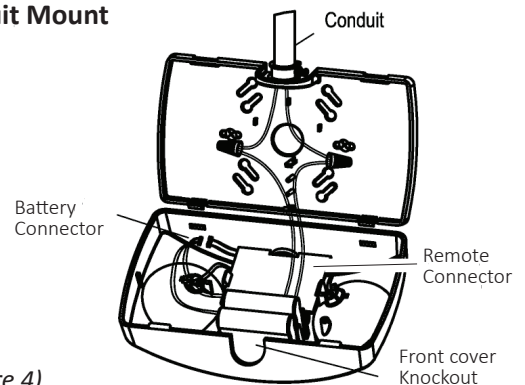

(Figure 4)

Adjust lamp head & Lens

Only narrow lens has adjustable function. Adjust the lamp heads and lens direction according to corridor or pathway as per needs.

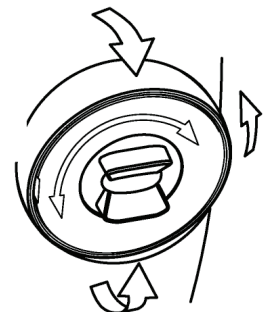

(Figure 5)

Installation Instructions

Ironclad® SRSEM LED Emergency Sign - CLEAR VANDAL COVER

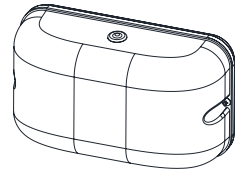

Instructions - Clear Vandal Cover

1. Disassemble clear vandal cover.

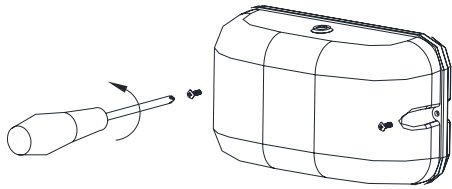

2. Knock out or drill center hole and appropriate mounting holes as required.

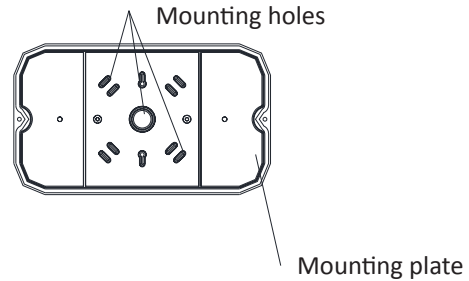

3. Install vandal mounting plate to J-Box.

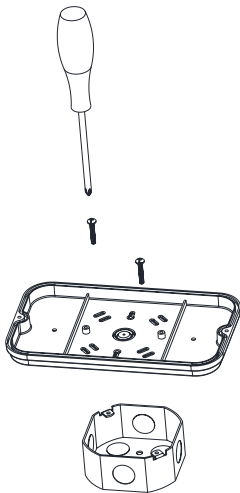

4. Secure emergency lighting back plate to vandal cover back plate, then snap the EM fixture to EM backplate.

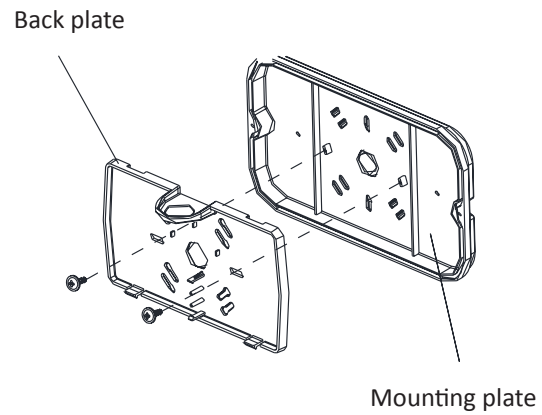

5. Assemble clear vandal cover by aligning silicone test button and EM test switch, then fasten with (2) supplied screws.

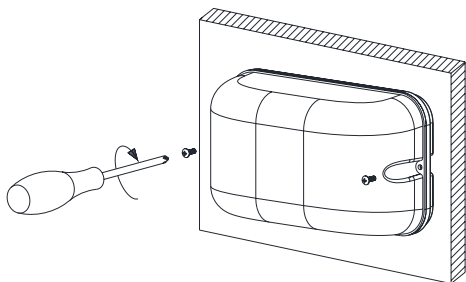

6. Test by pushing silicone test button. Lamp heads will turn on.

